



## SMB1N-490H

- Blue High Power LED
- 490 nm, 240 mW
- SMD package, PA9T
- Dimension: 5.0 x 5.2 x 1.0 mm
- Viewing Angle: 130°



### Description



**SMB1N-490H** is a surface mount InGaN High Power LED with a typical peak wavelength of **490 nm** and radiation of **240 mW**. It comes in SMD package (PA9T) with silver plated soldering pads (lead free solderable), copper heat sink, and molded with silicone resin.

### Maximum Ratings ( $T_{CASE}=25^{\circ}C$ )

Parameter	Symbol	Values		Unit
		Min.	Max.	
Power Dissipation	$P_D$		1400	mW
Forward Current	$I_F$		350	mA
Pulse Forward Current *1	$I_{FP}$		500	mA
Reverse Voltage	$V_F$		5	V
Thermal Resistance	$R_{THJA}$		10	KW
Junction Temperature	$T_J$		120	°C
Operating Temperature	$T_{CASE}$	- 40	+ 100	°C
Storage Temperature	$T_{STG}$	- 40	+ 100	°C
Lead Solder Temperature *2	$T_{SLD}$		+ 250	°C

\*1 duty=1%, pulse width = 10  $\mu$ s

\*2 must be completed within 5 seconds

### Electro-Optical Characteristics ( $T_{CASE}=25^{\circ}C$ )

Parameter	Symbol	Conditions	Values			Unit
			Min.	Typ.	Max.	
Peak Wavelength	$\lambda_P$	$I_F=350mA$	480		500	nm
Dominant Wavelength	$\lambda_D$	$I_F=350mA$		493		nm
Half Width	$\Delta\lambda$	$I_F=350mA$		26		nm
Forward Voltage	$V_F$	$I_F=350mA$		3.3	3.8	V
	$V_{FP}$	$I_{FP}=500mA$		3.5		
Radiated Power *1	$P_O$	$I_F=350mA$		240		mW
		$I_{FP}=500mA$		310		
Radiant Intensity *2	$I_E$	$I_F=350mA$		80		mW/sr
		$I_{FP}=500mA$		100		
Luminous Flux	$I_V$	$I_F=350mA$		70		lm
Viewing Angle	$\varphi$	$I_F=100mA$		130		deg.
Rise Time	$t_R$	$I_F=350mA$		50		ns
Fall Time	$t_F$	$I_F=350mA$		50		ns

\*1 measured by S3584-08

\*2 measured by CIE127-2007 Condition B



## Typical Performance Curves

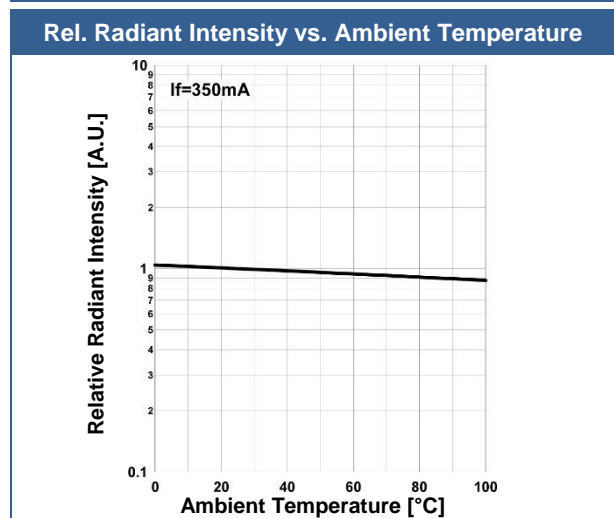
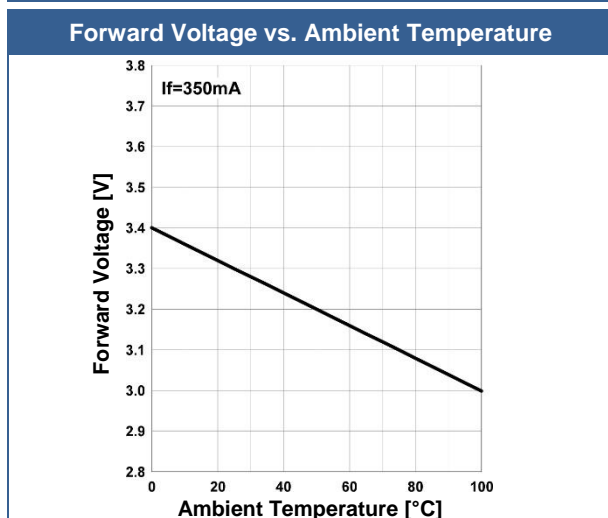
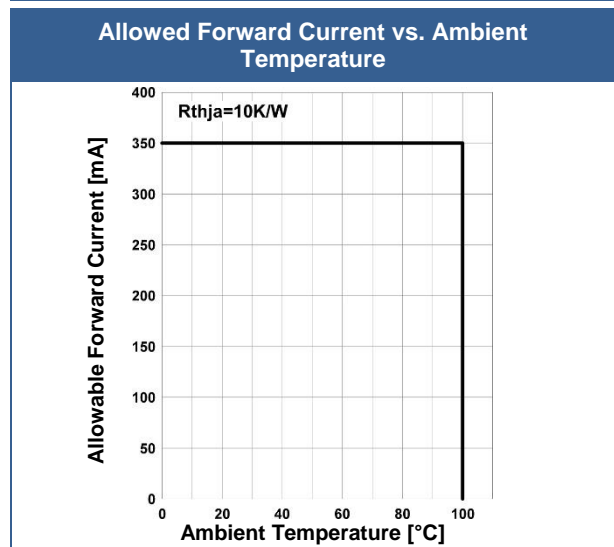
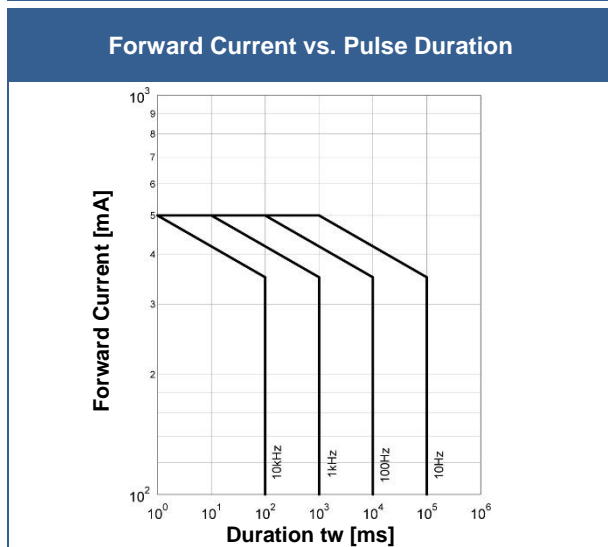
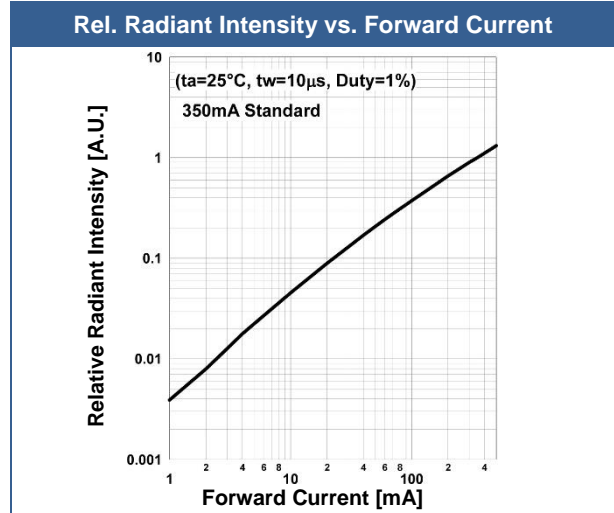
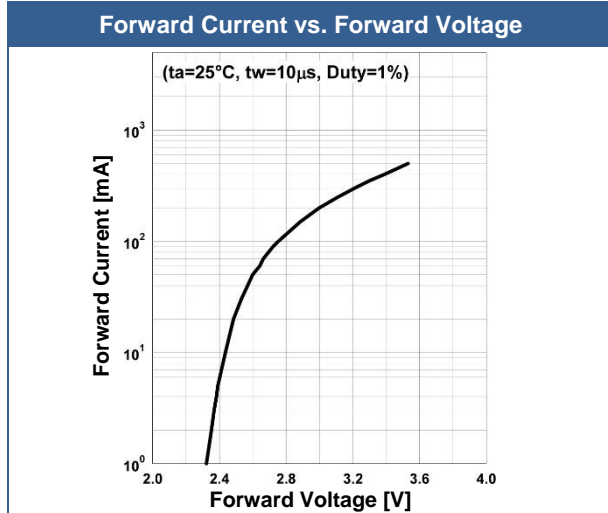



Peak Wavelength vs. Ambient Temperature

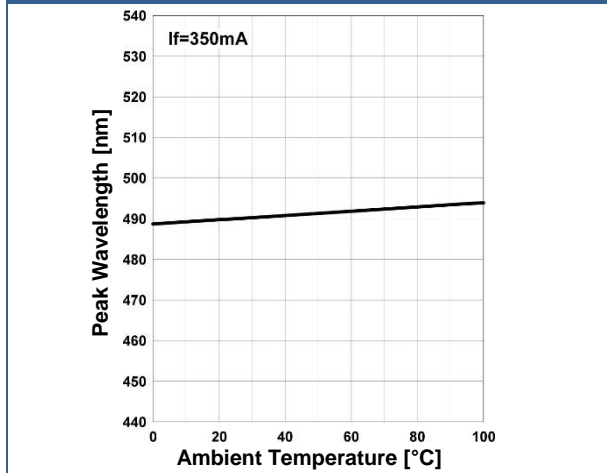

Relative Spectral Emission

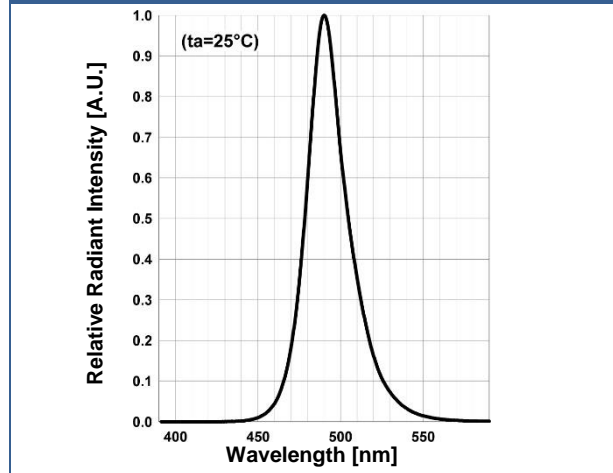

Radiation Characteristics

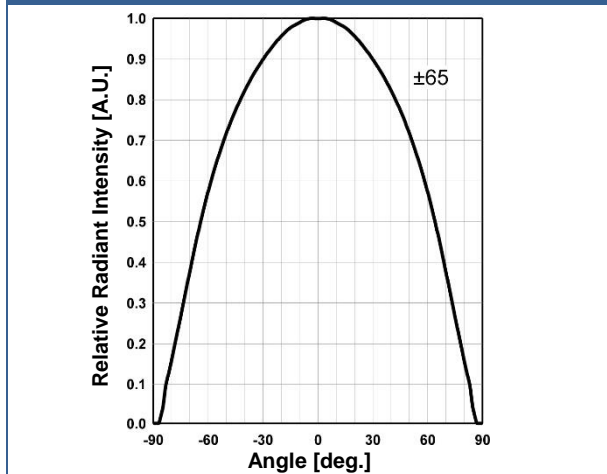

Radiation Characteristics

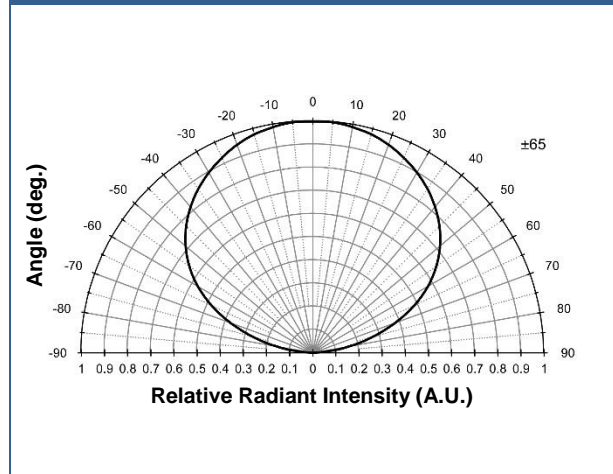

## Outline Dimensions

SMB1N
flat

Lead	Description
Pin a1	LED Anode
Pin c1	LED Cathode

All Dimensions in mm



## Precautions

### Soldering:

- Do avoid overheating of the LED
- Do avoid electrostatic discharge (ESD)
- Do avoid mechanical stress, shock, and vibration
- Do only use non-corrosive flux
- Do not apply current to the LED until it has cooled down to room temperature after soldering

### Recommended soldering conditions:

This LED is designed to be reflow soldered on to a PCB. If dip soldered or hand soldered, its reliability cannot be guaranteed.

Nitrogen reflow soldering is recommended. Air flow soldering conditions can cause optical degradation, caused by heat and/or atmosphere.

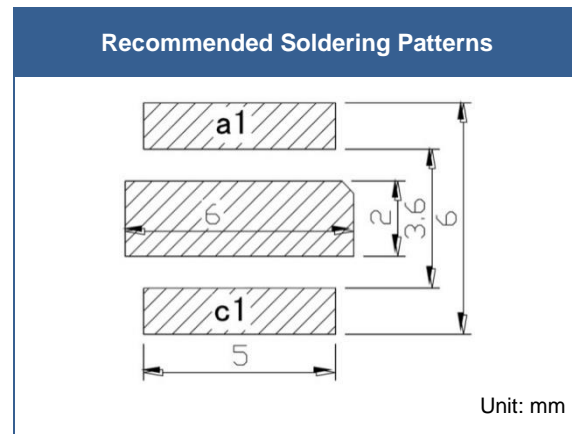
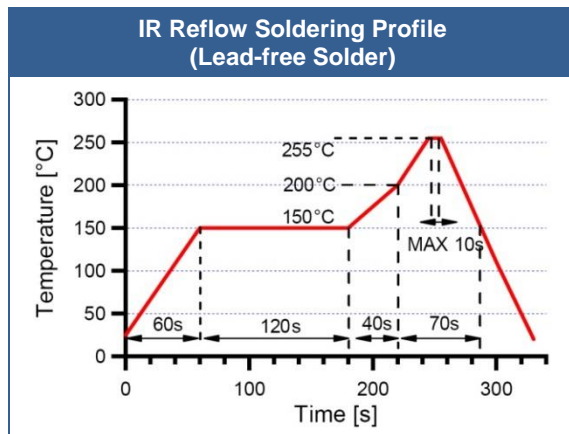

Above table specifies the maximum allowed duration and temperature during soldering. It is strongly advised to perform soldering at the shortest time and lowest temperature possible.

### Cleaning:

**Cleaning with isopropyl alcohol, propanol, or ethyl alcohol is recommended**

DO NOT USE acetone, chloroform, trichloroethylene, or MKS

DO NOT USE ultrasonic cleaners

### Static Electricity:

**LEDs are sensitive to electrostatic discharge (ESD).** Precautions against ESD must be taken when handling or operating these LEDs. Surge voltage or electrostatic discharge can result in complete failure of the device.

### Radiation:

During operation these LEDs do emit **high intensity light**, which is hazardous to skin and eyes, and may cause cancer. Do avoid exposure to the emitted light. **Protective glasses are recommended.** It is further advised to attach a warning label on products/systems.

### Operation:

**Do only operate LEDs with a current source.**

Running these LEDs from a voltage source will result in complete failure of the device.

Current of a LED is an exponential function of the voltage across it. Usage of current regulated drive circuits is mandatory.