



APG2C1-905



High Power Single Chip LED

APG2C1-905 is a GaAlAs based, high power 905 nm single chip LED in standard emitter package for general application.

Specifications

- Structure: GaAlAs
- Peak Wavelength: 905 nm
- Optical Output Power: typ. 70 mW
- Life Time: > 10.000 hours
- **Lead free product - RoHS compliant**



Absolute Maximum Ratings ($T_a=25^\circ\text{C}$)

Parameter	Symbol	Value	Unit
Power Dissipation, DC	P_D	1000	mW
Forward Current, DC	I_F	500	mA
Pulsed Current (1% duty cycle, 1kHz)	I_{FP}	1000	mA
Reverse Voltage	U_R	-5	V
Operating Temperature	T_{opr}	-30 ... +70	$^\circ\text{C}$
Storage Temperature	T_{stg}	-30 ... +85	$^\circ\text{C}$
Soldering Temperature (max. 1,5 s)	T_{sol}	330	$^\circ\text{C}$

Electro-Optical Characteristics ($T_a=25^\circ\text{C}$)

Parameter	Symbol	Condition	Min.	Typ.	Max.	Unit
Forward Current	I_F		-	350	-	mA
Viewing Angle	φ	$I_F = 350 \text{ mA}$	-	± 75	-	deg.
CW Output Power	P_O	$I_F = 350 \text{ mA}$	-	70	-	mW
Peak Wavelength	λ_P	$I_F = 350 \text{ mA}$	-	905	-	nm
Forward Voltage	U_F	$I_F = 350 \text{ mA}$	-	1.3	-	V
Half Width (FWHM)	$\Delta\lambda$	$I_F = 350 \text{ mA}$	-	68	-	nm
Rise Time	t_r	$I_F = 350 \text{ mA}$		400		ns
Fall Time	t_f	$I_F = 350 \text{ mA}$		400		ns

Wavelength measurements tolerance is +/- 2%
Output power measurement tolerance is +/- 10%
Voltage measurement tolerance is +/- 2%

Device Materials

Item	Material
Foundation	Plastic
Lens	Acryl
Electrodes	AgCu
Heat Sink	AgCu

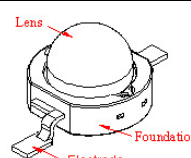



Typical Performance Characteristics

Normalized Output Power vs. Wavelength:

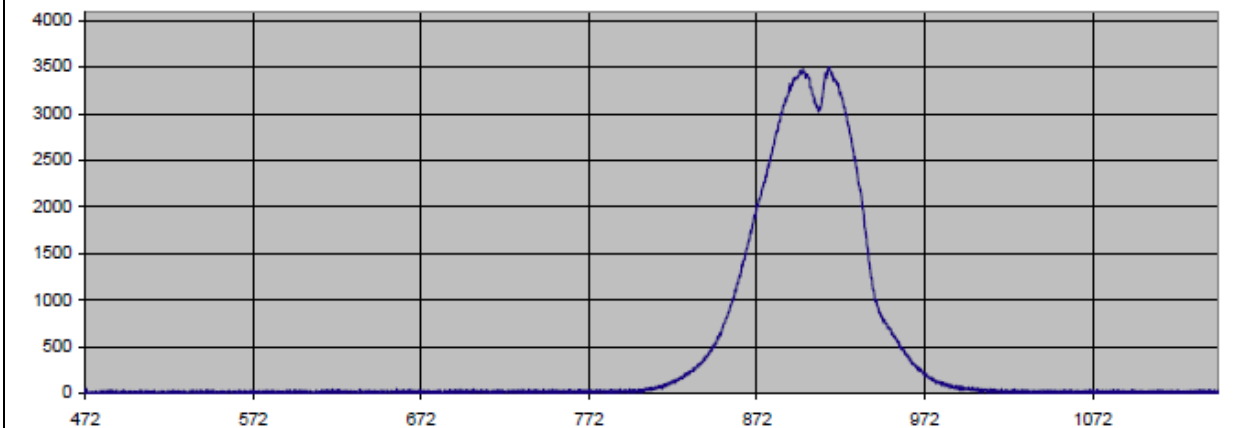

Outline Dimensions

Emitter:

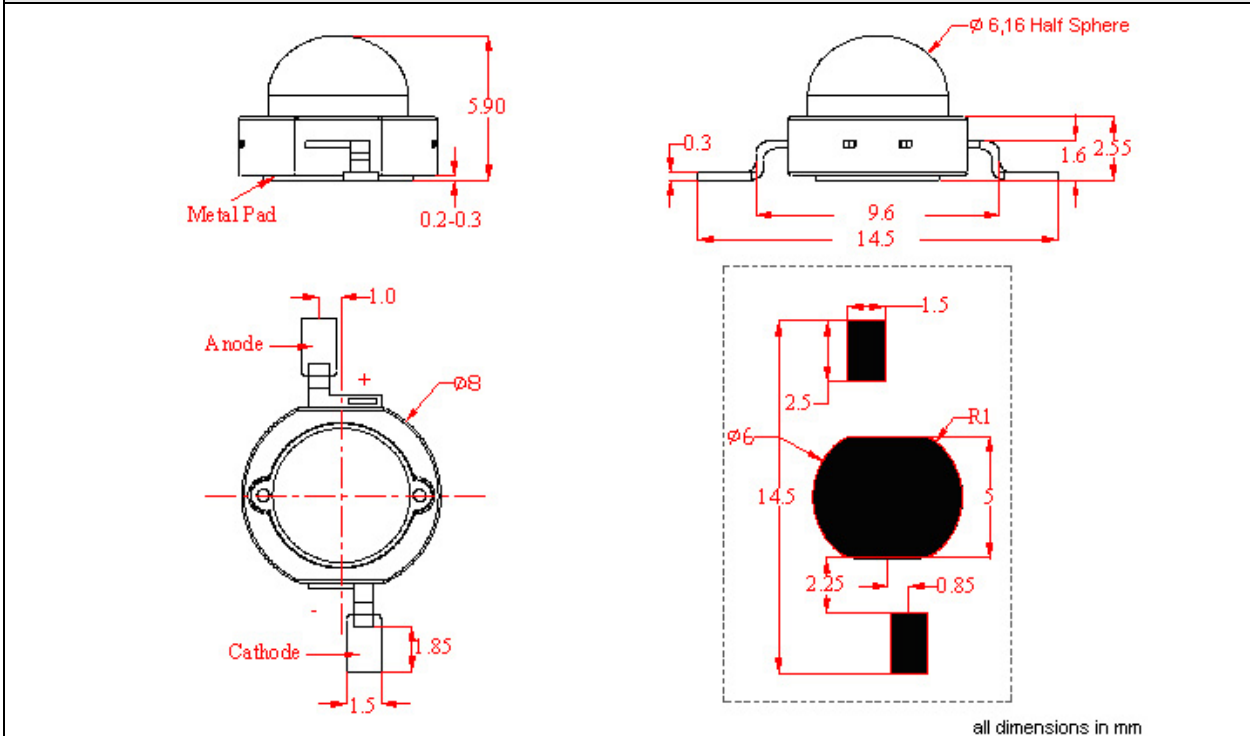



Radiation Pattern (Lambertian lens without optics)

Relative Intensity vs. Angular Displacement

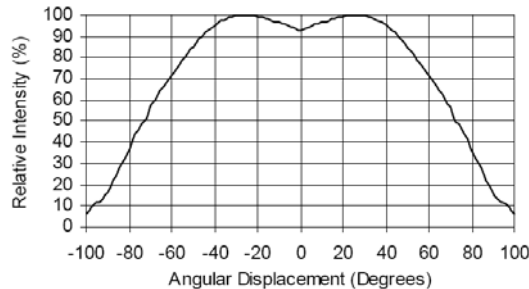

Accessories

Collimating optics, holders, reflectors

- 10158 + 10146, 2° half angle spot optic + optic holder
- 10048 + 10076, 4° half angle spot optic + optic holder
- 10003 + 10043, 6° half angle spot optic + optic holder
- 10003/15 + 10043, 15° half angle spot optic + optic holder
- 10003/25 + 10043, 25° half angle spot optic + optic holder
- CLP17CR, 6° metalized polycarbonate reflector
- CLP23CR, 20° metalized polycarbonate reflector



Static Electricity

LEDs are very sensitive to static Electricity and surge voltage. It is recommended to wear a wristband or an anti-electrostatic glove whenever handling the LEDs

All devices, equipment, and machinery that is used when handling the LEDs must be grounded properly.



Heat Generation

It is advised to operate these LEDs at a reasonable low temperature for long lifetime and stability. High operating temperature will result in premature degradation and shortened lifetime.





Soldering Conditions

Reflow Soldering:

APG2C1 LEDs have a maximum storage temperature of 85°. Therefore it is not possible to use a reflow soldering process for array assembly!

Hot Bar Soldering:

A Hot Bar Soldering process is recommended when soldering APG2C1 emitters. This process will only transfer heat to the leads and avoids overheating the emitter which will damage the device. In order to transfer sufficient heat from the hot bar to the device, following parameters must be carefully considered:

- Amount of flux
- Pressing force of solder tip
- Hot bar temperature

For the standard assembly process, following parameters should be maintained:

- Hot Bar temperature: 330 °C
- Force of Hot Bar: 40 N
- Soldering time: 1.5 s

It is recommended to use a copper nickel-plated hot bar mounted to standard temperature controlled soldering equipment.

Manual Hand Soldering:

For prototype build or small series production runs, it is possible to place and solder the emitters by hand. It is therefore recommended to maintain the following parameters:

- Solder Tip Temperature 330 °C
- Soldering time: < 1.5 s
- Junction temperature must be kept below 70 °C

A visual inspection may be used to check the quality of the solder joint

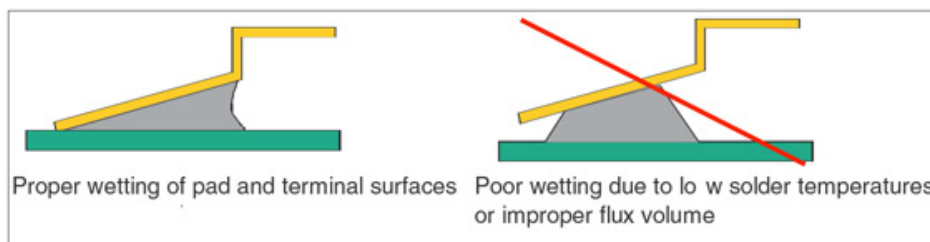

General Soldering Precautions:

- Mechanical stress, shock and vibration must be avoided during soldering
- Only use non corrosive flux.
- Do not apply current to the device until it has cooled down to room temperature after soldering.



NOTE
HIGH POWER LED
MUST BE COOLED