



LED450-66-60

- Blue High Power LED Array
- 450 nm, 700 mW
- Chip: 350x350 μm , 60 pcs., InGaN
- TO-66 package, Silicone and/or Epoxy resin
- Viewing Angle: 130°



Description

LED450-66-60 is a wide viewing and extremely high output power illuminator consists of 60 pcs. of InGaN chip dies, mounted on a metal stem TO-66 package with AlN ceramics and covered with clear silicone and/or epoxy resin.

On forward bias, it emits a power radiation of typical **700 mW** at a peak wavelength of **450 nm**.

Maximum Ratings ($T_{CASE}=25^{\circ}\text{C}$)

Parameter	Symbol	Values		Unit
		Min.	Max.	
Power Dissipation	P_D		12	W
Forward Current	I_F		600	mA
Reverse Voltage	V_R		25	V
Thermal Resistance	R_{THJA}		2	K/W
Junction Temperature	T_J		120	$^{\circ}\text{C}$
Operating Temperature	T_{CASE}	- 40	+ 85	$^{\circ}\text{C}$
Storage Temperature	T_{STG}	- 40	+ 100	$^{\circ}\text{C}$
Lead Solder Temperature *	T_{SLD}		+ 265	$^{\circ}\text{C}$

* must be completed within 3 seconds

Electro-Optical Characteristics ($T_{CASE}=25^{\circ}\text{C}$)

Parameter	Symbol	Conditions	Values			Unit
			Min.	Typ.	Max.	
Peak Wavelength	λ_P	$I_F=240\text{mA}$	440		460	nm
Half Width	$\Delta\lambda$	$I_F=240\text{mA}$		20		nm
Forward Voltage	V_F	$I_F=240\text{mA}$		14.8	20	V
Radiated Power *	P_O	$I_F=240\text{mA}$		700		mW
Luminous Flux	Φ_V	$I_F=240\text{mA}$		30		lm
Viewing Angle	$2\theta_{1/2}$	$I_F=100\text{mA}$		124		deg.
Rise Time	t_R	$I_F=240\text{mA}$		30		ns
Fall Time	t_F	$I_F=240\text{mA}$		30		ns

* measured by S3584-08



Typical Performance Curves

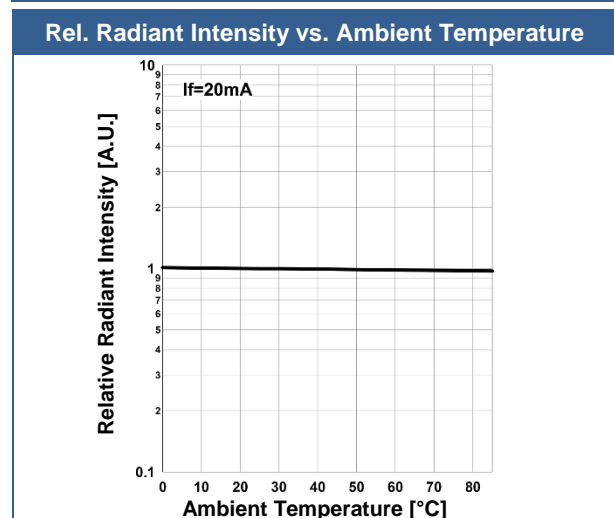
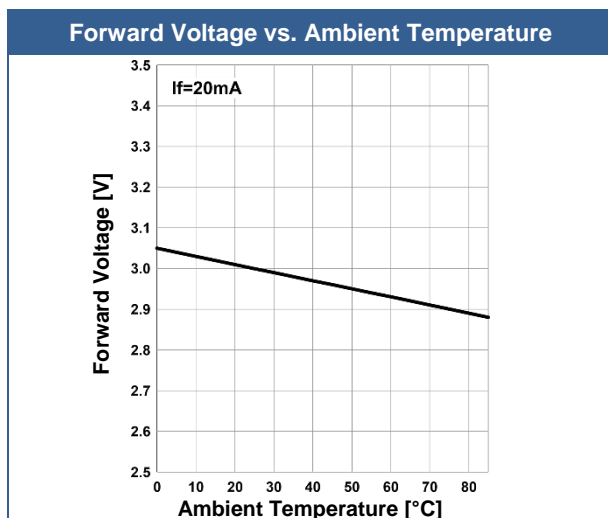
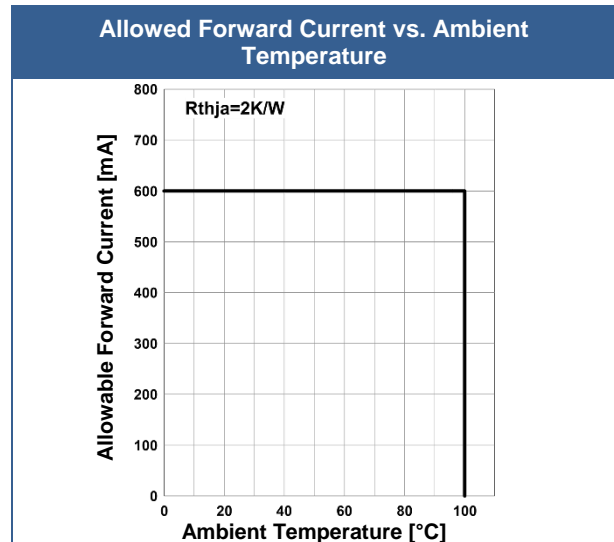
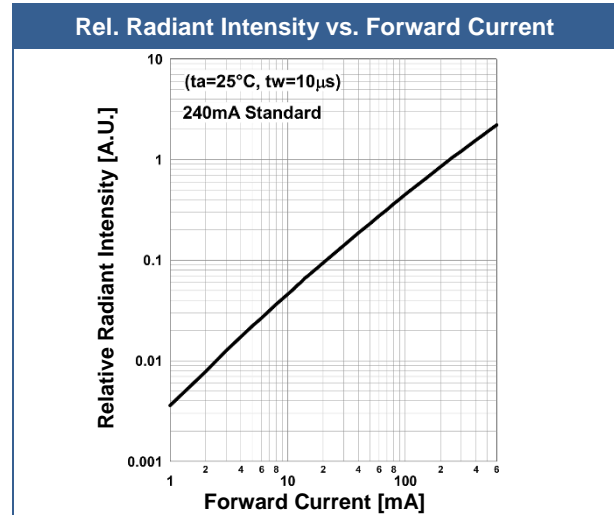
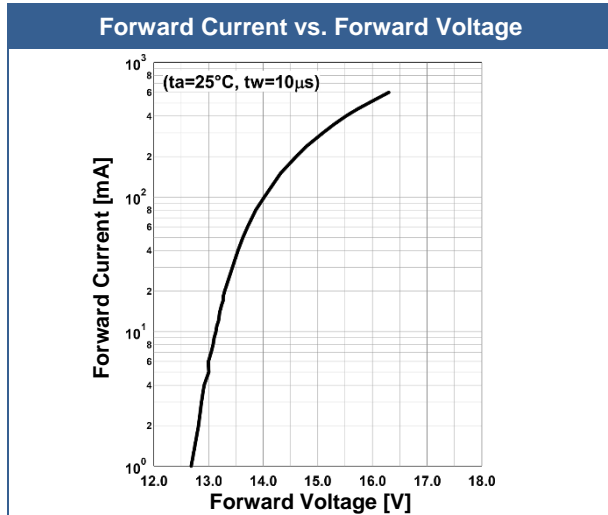



Peak Wavelength vs. Ambient Temperature

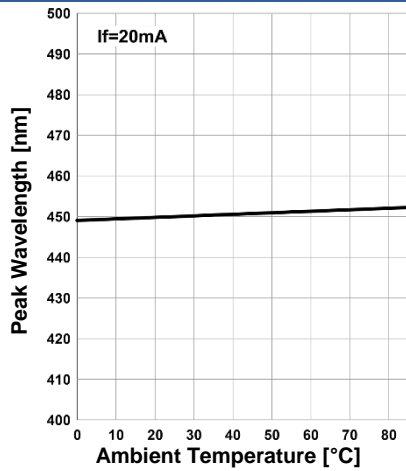

Relative Spectral Emission

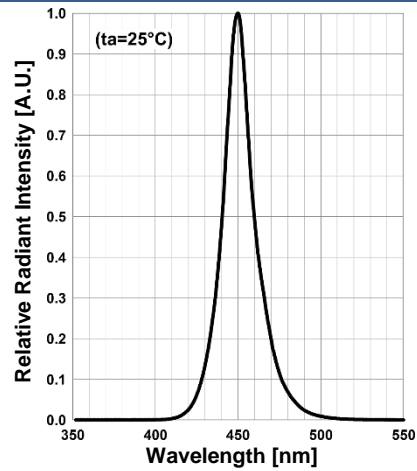

Radiation Characteristics

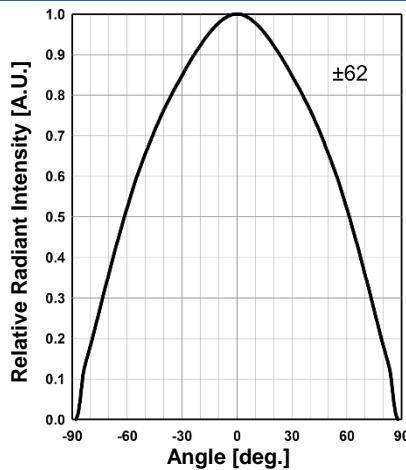

Radiation Characteristics

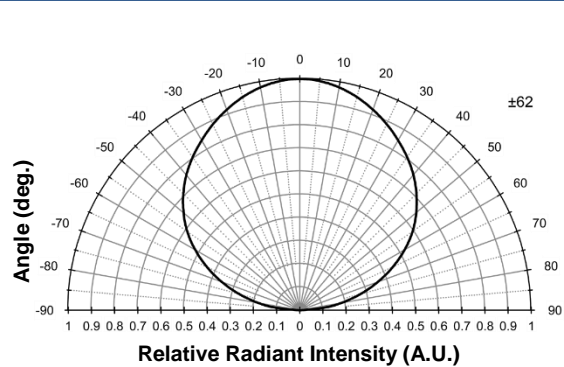

Outline Dimensions

LED450-66-60

TO-66

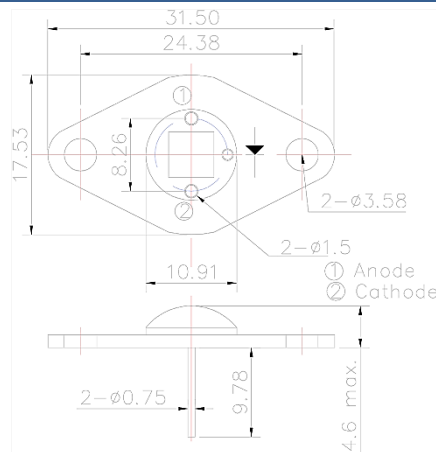

Lead	Description
Pin 1	LED Anode
Pin 2	LED Cathode

All Dimensions in mm



Precautions

Cautions:

- This high power LED must be cooled!
- NOT look directly into the emitting area of the LED during operation!

Soldering:

- Do avoid overheating of the LED
- Do avoid electrostatic discharge (ESD)
- Do avoid mechanical stress, shock, and vibration
- Do only use non-corrosive flux
- Do not apply current to the LED until it has cooled down to room temperature after soldering

Cleaning:

Cleaning with isopropyl alcohol, propanol, or ethyl alcohol is recommended

DO NOT USE acetone, chloroform, trichloroethylene, or MKS

DO NOT USE ultrasonic cleaners

Static Electricity:

LEDs are sensitive to electrostatic discharge (ESD). Precautions against ESD must be taken when handling or operating these LEDs. Surge voltage or electrostatic discharge can result in complete failure of the device.

Radiation:

During operation these LEDs do emit **high intensity light**, which is hazardous to skin and eyes, and may cause cancer. Do avoid exposure to the emitted light. **Protective glasses are recommended.** It is further advised to attach a warning label on products/systems.

Operation:

Do only operate LEDs with a current source.

Running these LEDs from a voltage source will result in complete failure of the device.

Current of a LED is an exponential function of the voltage across it. Usage of current regulated drive circuits is mandatory.



Revisions History

Rel.	Rel. Date	Chapter	Modification	Page
A2	2020-08-26	Maximum Ratings	P_D : 12 W (previously 8 W) I_F : 600 mA (previously 400 mA) V_R : 25 V (previously 50 V) T_{CASE} : -40..+85 °C (previously -30..+80 °C) T_{CASE} : -40..+100 °C (previously -30..+110 °C) T_{SLD} : 265 °C (previously -240 °C) Included: Thermal Resistance, Junction Temperature	1
		Electro-Optical Characteristics	$\Delta\lambda$: typ. 30 nm (previously typ. 30 nm) V_F : typ. 14.8 V / max. 20 V (previously typ. 18 V) $2\theta_{1/2}$: 124° (previously $\pm 60^\circ$) P_O : typ. 700 mW (previously typ. 40 mW) t_R : typ. 30 ns (previously typ. 1000 ns) t_F : typ. 40 ns (previously typ. 400 ns) Included: Φ_V , t_R , t_F	1
		Typical Performance Curves	included	2-3
A1	2012-04-25	-	Initial release	-

© All Rights Reserved

The above specifications are for reference purpose only and subjected to change without prior notice