



XSL-370-TB5



TECHNICAL DATA

UV LED, TO46 with glass ball lens

Drawing

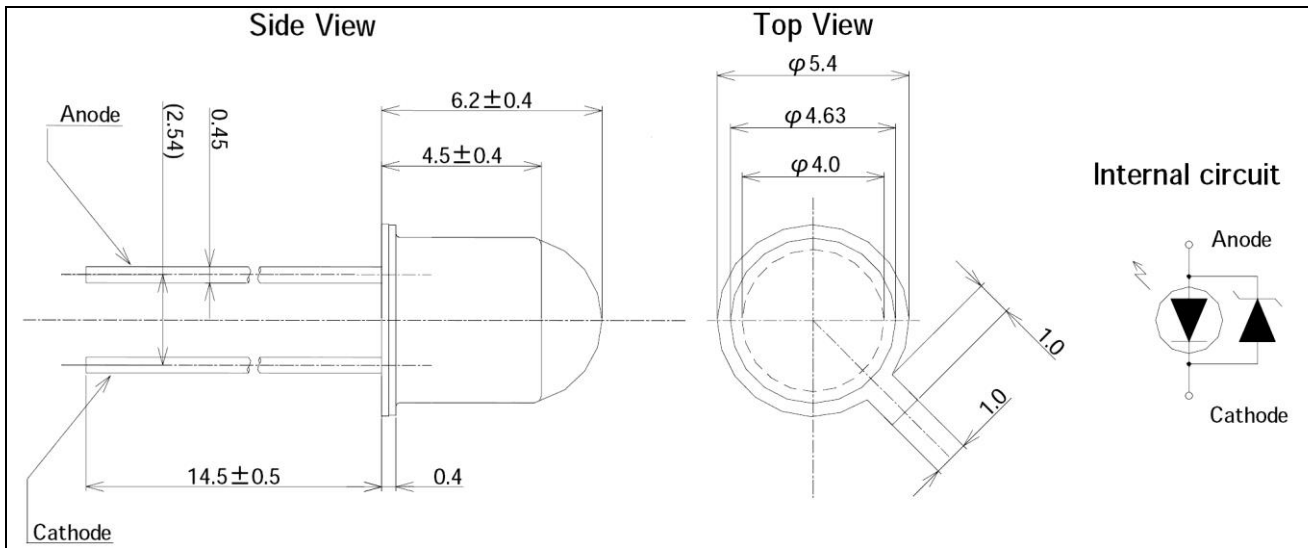

Absolute Maximum Ratings ($T_a=25^\circ\text{C}$)

Item	Symbol	Value	Unit
DC Forward Current	I_F	25	mA
Peak Pulse Forward Current *1	I_{FP}	100	mA
Power Dissipation	P_D	100	mW
Operating Temperature	T_{OP}	-30 ... +80	$^\circ\text{C}$
Storage Temperature	T_{STG}	-30 ... +100	$^\circ\text{C}$
Soldering Temperature *2	T_{SOL}	260	$^\circ\text{C}$

*1 pulse width ≤ 0.1 ms, duty ratio $\leq 1/10$

*2 for 10 sec.

Specifications ($I_f=20\text{mA}$, $T_a=25^\circ\text{C}$)

Item	Symbol	Min.	Typ.	Max.	Unit
Electrical Specification					
Forward Voltage *1	U_F	3.2	3.6	4.2	V
Optical Specification					
Optical Power	P_O	1.2	-	1.8	mW
Peak Wavelength *2	λ_P	370	-	375	nm
Spectral Half Width (FWHM)	λ	-	12	-	nm
Viewing Angle	φ	15			deg.

* Note:

1. measurement tolerance is ± 0.2 V
2. measurement tolerance is ± 2 nm



Typical Performance Curves

forward voltage vs. forward current:

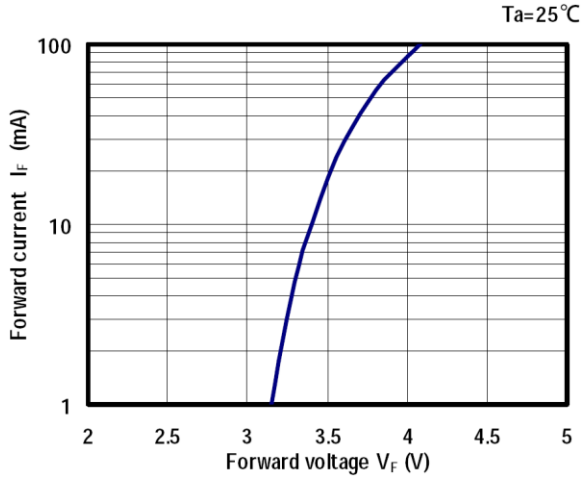

forward voltage vs. relative output power:

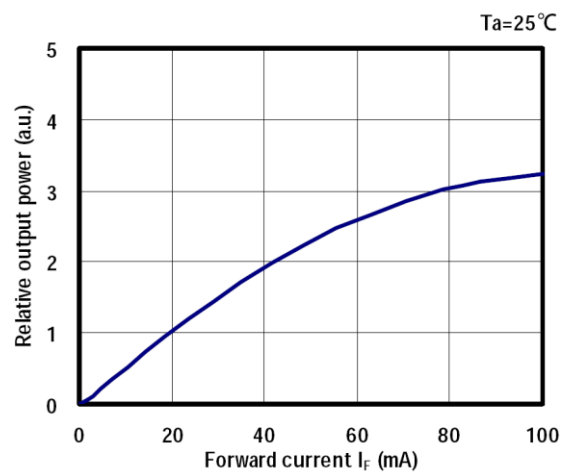

ambient temperature vs. relative output power:

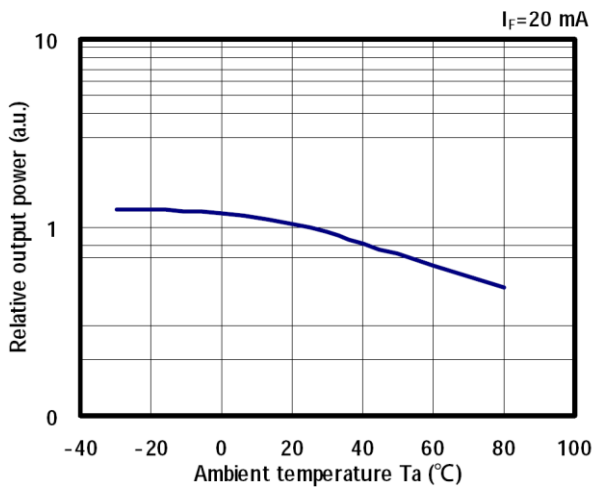

ambient temperature vs. forward voltage:

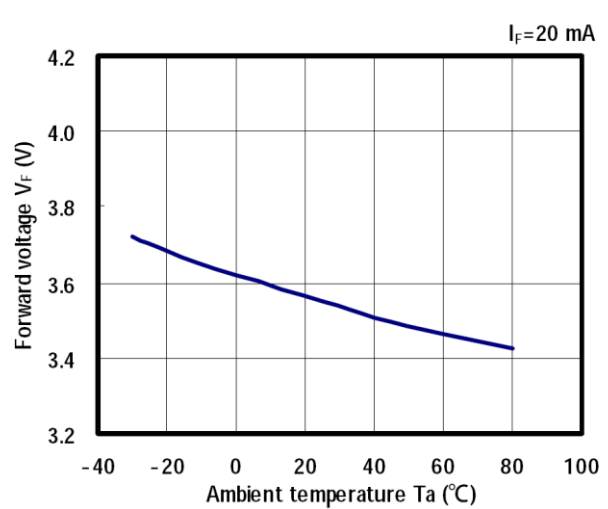

ambient temp. vs. maximum forward current:

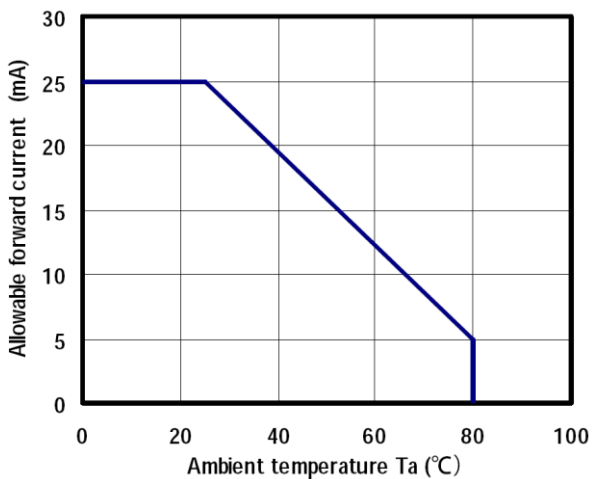

spectrum:

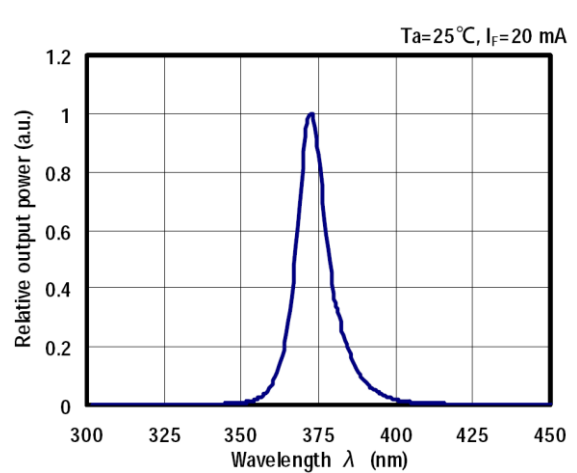



directivity:

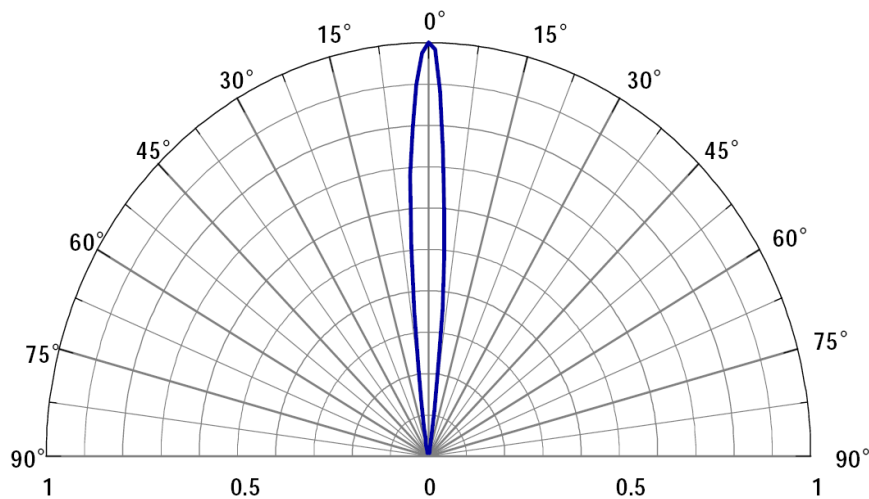

Device Materials

Item	Material
Glass lens	Hard glass
Header	Ni-plated iron alloy
Lead	Au-plated iron alloy
XSL-370-TB is RoHS compliant	

Precaution for Use

1. Cautions

- This device is a UV LED, which radiates intense UV light during operation.
- DO NOT look directly into the UV light or look through the optical system. To prevent inadequate exposure of UV radiation, wearing UV protective glasses is recommended

2. Lead Forming

- When forming leads, the leads should be bent at a point at least 3 mm from the base of the lead. DO NOT use the base of the leadframe as a fulcrum during lead forming.
- Lead forming should be done before soldering.
- DO NOT apply any bending stress to the base of the lead. The stress to the base may damage the LED's characteristics or it may break the LEDs.
- When mounted the LEDs onto the printed circuit board, the holes on the circuit board should be exactly aligned with the leads of LEDs. If the LEDs are mounted with stress at the leads, it causes deterioration of the lead and it will degrade the LEDs.



3. Soldering Conditions

- Solder the LEDs no closer than 3 mm from the base of the lead.
- Recommended soldering conditions:

Dip Soldering		Hand Soldering	
Pre-Heat	120 °C Max.	Temperature	350 °C Max.
Pre-Heat Time	60 Seconds Max.	Soldering Time	3 Seconds Max.
Solder Bath Temperature	260 °C Max.	Position	Not closer than 3 mm from the base of the epoxy bulb
Dipping Time	5 Seconds Max.		
Dipping Position	No lower than 3 mm from the base of the epoxy bulb		

- Although the recommended soldering conditions are specified in the above table, dip or hand soldering at the lowest possible temperature is desirable for the LEDs.
- A rapid-rate process is not recommended for cooling the LEDs down from the peak temperature.
- Dip soldering and hand soldering should not be done more than one time.
- Do not apply any stress to the lead particularly when heated.
- The LEDs must not be repositioned after soldering.
- After soldering the LEDs, the lead should be protected from mechanical shock or vibration until the LEDs return to room temperature.
- Direct soldering onto a PC board should be avoided. Mechanical stress to the resin may be caused from warping of the PC board or from the clinching and cutting of the lead frames. When it is absolutely necessary, the LEDs may be mounted in this fashion but the customer will assume responsibility for any problems. Direct soldering should only be done after testing has confirmed that no damage, such as wire bond failure or resin deterioration, will occur. Those LEDs should not be soldered directly to double sided PC boards because the heat will deteriorate the epoxy resin.
- When it is necessary to clamp the LEDs to prevent soldering failure, it is important to minimize the mechanical stress on the LEDs.
- Cut the LED leads at room temperature. Cutting the leads at high temperature may cause the failure of the LEDs.

4. Static Electricity

- The LEDs are very sensitive to Static Electricity and surge voltage. So it is recommended that a wrist band or an anti-electrostatic glove be used when handling the LEDs.
- All devices, equipment and machinery must be grounded properly. It is recommended that precautions should be taken against surge voltage to the equipment that mounts the LEDs.





5. Heat Generation

- Thermal design of the end product is of paramount importance. Please consider the heat generation of the LED when making the system design. The coefficient of temperature increase per input electric power is affected by the thermal resistance of the circuit board and density of LED placement on the board, as well as other components. It is necessary to avoid intense heat generation and operate within the maximum ratings given in the specification.
- The operating current should be decided after considering the ambient maximum temperature of LEDs.

6. Storage

- The LEDs should be stored at 30°C or less and 70%RH or less after being shipped and the storage life limits are 3 months. If the LEDs are stored for 3 months or more, they can be stored for a year in a sealed container with nitrogen atmosphere and moisture absorbent material.
- Please avoid rapid transitions in ambient temperature, especially in high humidity environments where condensation can occur.