

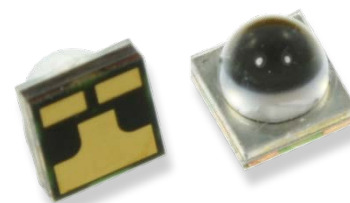

UVR270-SC3

- Deep Ultraviolet Light Emission Source
- 270 nm, 3 mW
- All Metal Design
- Beam Angle 30 deg.



Description

UVR270-SC3 is an AlGaIn based single emitter **DEEP-UV LED** with a typical peak wavelength of **270 nm** and an optical output power of **3 mW** at a current of **50 mA**. It comes in an all metal 4545 SMD package with low thermal resistance. **UVR270-SC3** is ready for reflow soldering process, and can be delivered on tape and reel.

Maximum Rating ($T_{CASE} = 25^{\circ}C$)

Parameter	Symbol	Values		Unit
		Min.	Max.	
Power Dissipation, DC	P_D		500	mW
Forward Current*	I_F		50	mA
Thermal Resistance (junction-case)	R_{thv}		15	$^{\circ}C/W$
Operating Temperature*	T_{OPR}	- 40	+ 60	$^{\circ}C$
Storage Temperature	T_{STG}	- 40	+ 100	$^{\circ}C$
Soldering Temperature (max. 5s)	T_{SOL}		260	$^{\circ}C$

* Operation close to the absolute maximum ratings may affect device reliability



Electro-Optical Characteristics ($T_{CASE} = 25^{\circ}C, I_F = 50 mA$)

Parameter	Symbol	Values			Unit
		min.	typ.	max.	
Peak Wavelength*	λ_P	265		275	nm
Radiated Power**	P_O	2	3		mW
Spectral Width (FWHM)	$\Delta\lambda$		15		nm
Forward Voltage	V_F		8		V
Viewing Angle	$2\theta_{1/2}$		30		deg.

*Peak Wavelength measurement tolerance is $\pm 3nm$

**Radiated power measurement tolerance is $\pm 10\%$

Electrical Connection

Pad	Function
1	Cathode
2	Anode
3	Heat Sink

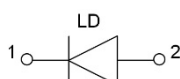

Bottom View:

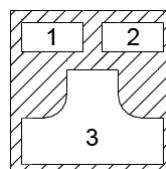



Outline Dimensions

SMD

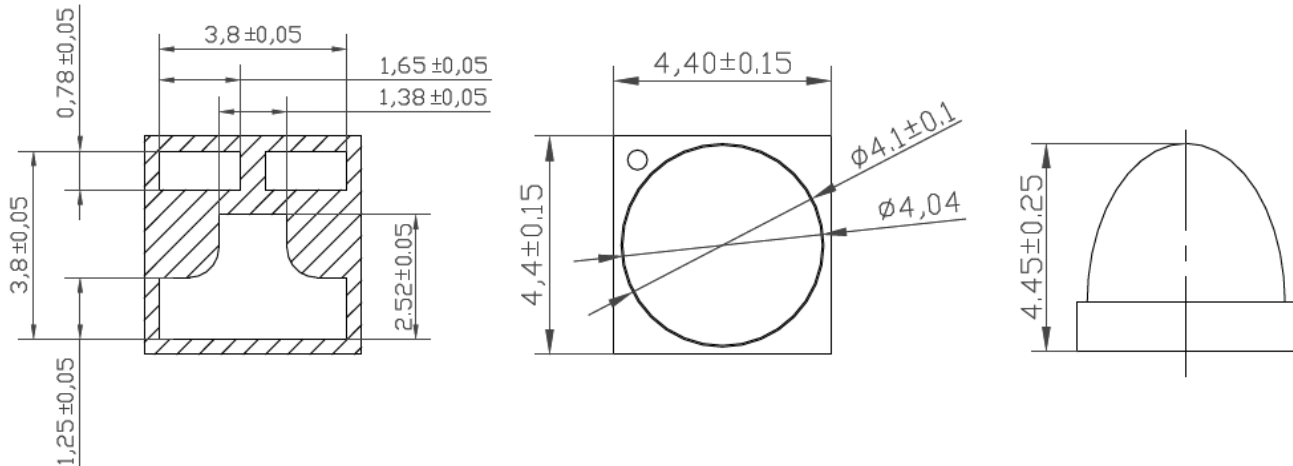

all dimensions in mm

Performance Characteristics

Forward Current vs. Forward Voltage

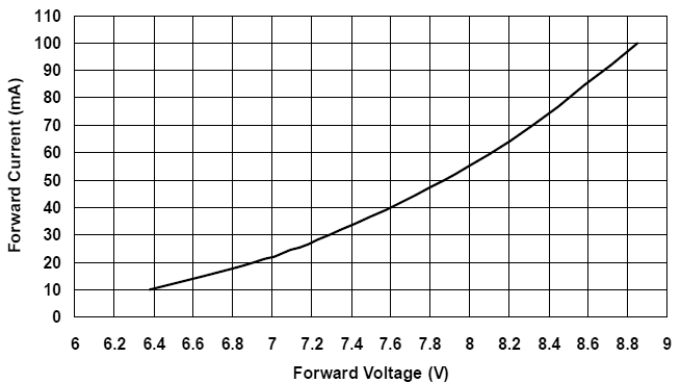

Relative Intensity vs. Forward Current

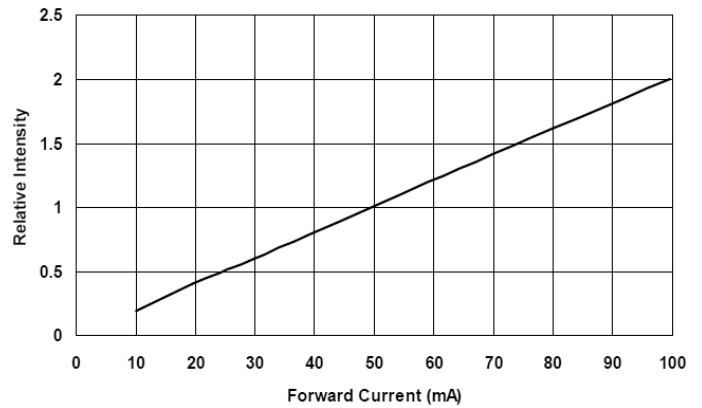

Spectrum

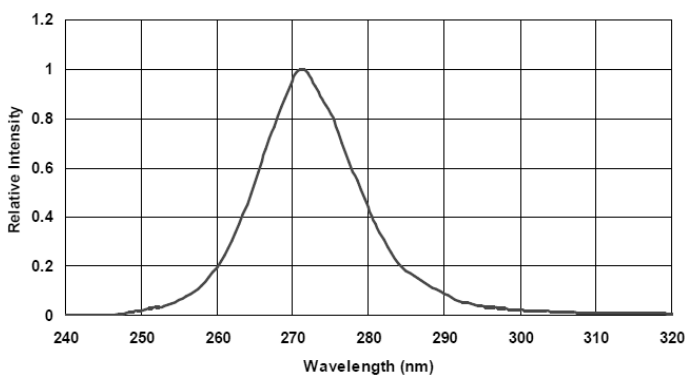

Radiation Pattern

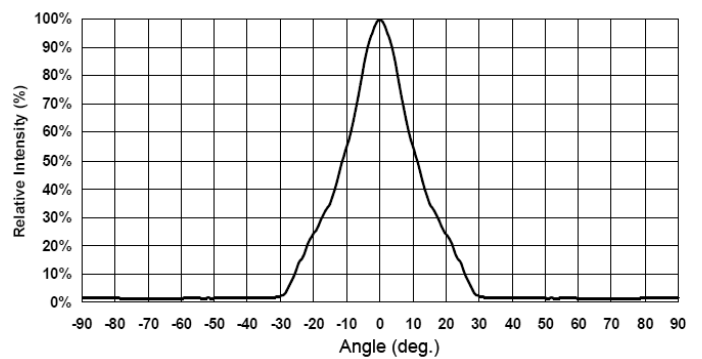



Precautions

Recommended Reflow Soldering Profile

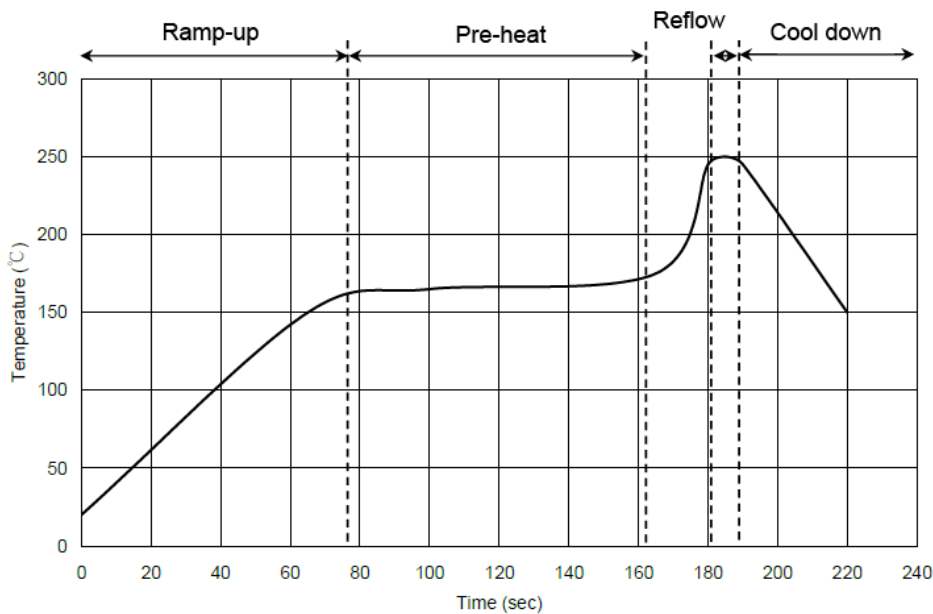

Process	Parameter
Ramp-up rate	< 3 °C/s
Ramp-up time	50-80 s
Pre-heat temp.	150-180 °C
Pre-heat time	< 120 s
Reflow time	< 10 s
Reflow ramp rate	< 2 °C/s
Reflow temp	< 250 °C
Cool down rate	< 5 °C/s

Static Electricity

LEDs are sensitive to electrostatic discharge (ESD). Precautions against ESD must be taken when handling or operating these LEDs. Surge voltage or electrostatic discharge can result in complete failure of the device.

UV-Radiation

During operation these LEDs do emit **high intensity ultraviolet light**, which is hazardous to skin and eyes, and may cause cancer. Do avoid exposure to the emitted UV light. **Protective glasses are recommended.** It is further advised to attach a warning label on products/systems that do utilize UV-LEDs:

Operation

Do only operate LEDs with a current source.

Running these LEDs from a voltage source *will* result in complete failure of the device.

Current of a LED is an exponential function of the voltage across it. Usage of current regulated drive circuits is mandatory



Cleaning

For **cleaning**, it is advised to use alcohol based solvents like **isopropyl alcohol**