



RLT940-300GS

- Infrared Laser Diode
- 940 nm, 300 mW
- Single mode



Description

RLT940-300GS is a infrared laser diode, based on InGaN quantum structures, typically emitting at 940 nm. It features single mode emission, and is TE polarized. **RLT940-300GS** comes in 9 mm TO-Can package with **integrated PD**.

Maximum Rating* ($T_{CASE} = 25^{\circ}C$)

Parameter	Symbol	Values		Unit
		Min.	Max.	
Optical Output Power* ¹	P_{MAX}		330	mW
Operating Temperature* ²	T_{OPR}	- 20	+ 50	$^{\circ}C$
Storage Temperature	T_{STG}	- 40	+ 80	$^{\circ}C$
Soldering Temperature (max. 5s)	T_{SOL}		+ 250	$^{\circ}C$

*¹ kink-free power, operating above may irreversibly damage the device

*² operating outside these conditions may damage the device



Electro-Optical Characteristics ($T_{CASE} = 25^{\circ}C$)

Parameter	Symbol	Values			Unit
		Min.	Typ.	Max.	
Peak Wavelength	λ_P	935	940	945	nm
Optical Output Power	P_O		300		mW
Spectral Width (FWHM)	$\Delta\lambda$		0.5	2.0	nm
Operating Voltage	V_F		1.9	2.2	V
Threshold Current	I_{th}		20	40	mA
Operating Current	I_F		400	450	mA
Slope Efficiency	CW	0.80	0.90		W/A
Lifetime		100000			h
Beam Divergence (FWHM)	parallel	$\theta_{ }$	8	10	deg.
	perpendicular	θ_{\perp}	20	40	deg.

Electrical Connection

Pin Configuration

Pin #	Function
Pin 1	LD Anode
Pin 2	LD Cathode, PD Cathode
Pin 3	PD Anode

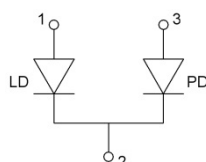

Bottom View

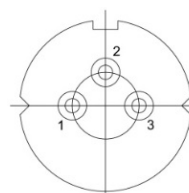



Outline Dimensions

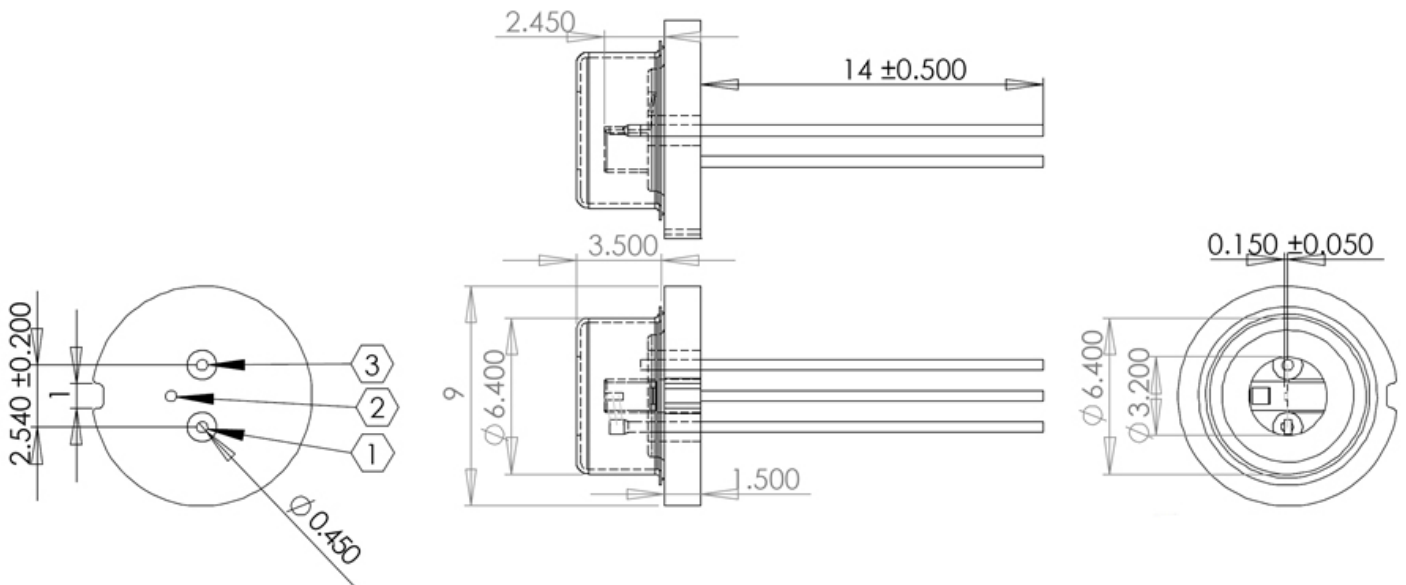

All dimensions in mm

Precautions

Safety

Warning: Invisible laser radiation is emitted from this device !!!

Caution: Laser light emitted from any laser diode may be **harmful to the human eye**. Avoid looking directly into the laser diode's aperture when the diode is in operation.

Note: The use of optical lenses with this laser diode will increase eye hazard

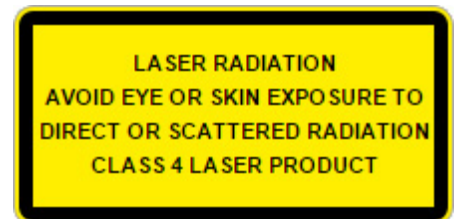

ESD caution

Always do handle laser diodes with extreme care to **prevent electrostatic discharge**, the primary cause of unexpected diode failure. To prevent ESD related failures, it is strongly advised to always **wearing wrist straps**, and **grounding all applicable work surfaces**, when handling laser diodes

Operating Considerations

It is strongly advised to only operate this laser diode with a current source. The current of a laser diode is an exponential function of the voltage across it. **Usage of current regulated drive circuits is mandatory**. Laser diodes may be damaged by excessive drive currents or switching transients

It is advised, to operate the laser diode at the lowest temperature possible, and to never exceed maximum specifications as outlined in the datasheet. Device degradation will accelerate with increased temperature. **Proper heat sinking will greatly enhance stability and life time of the laser diode**